

Before using the GS-50T, check the following:

- Is the power supply to the machine switched on?
- Is the overflow pipe and filters in place?
- Is there sufficient detergent and rinse aid?
- Is the water supply valve open?

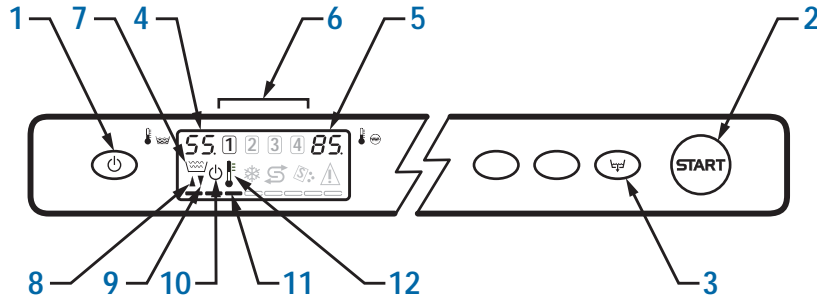

- (1) ON/OFF/STAND-BY
- (2) Push button to start cycle/select cycle
- (3) Push to drain (optional)
- (4) Tank temperature display
- (5) Boiler temperature display
- (6) Cycle indicator
- (7) Tank filling/draining indicator
- (8) Filling indicator
- (9) Draining indicator
- (10) STAND-BY indicator
- (11) Cycle scroll bar
- (12) Set temperature reached indicator

Starting the machine

1. Close the door and press the ON/OFF switch (1). A symbol (10) will now turn off and the temperature displays (4) & (5) will light up indicating that the machine is switched on. The machine will automatically start filling with water to the required level indicated by (7), (8) & (11).

The machine will be ready for use when the indicator (12) is on. This means the washing and rinsing water temperature has been reached as per HACCP and hygiene regulations. The displays (4) and (5) will show the temperatures respectively.

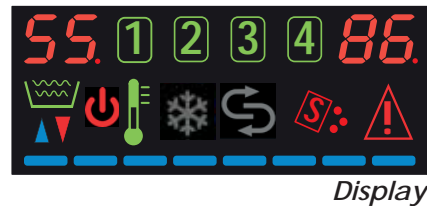

2. For machines with automatic detergent dispensing equipment, insert the green rinse-aid dispenser tube in the rinse aid container and the clear tube in the detergent bottle as per the supplier's instructions. The detergent dispensers will inject the necessary detergent automatically.

For manually dispensing of detergent, pour approximately 35 grams of detergent into the wash tank. Never pour washing powder over the tableware, as this will cause stains. Use only washing powder or liquid detergent recommended for use in a commercial dishwashing machine. The detergent has to be added only every 4-5 cycles, depending on how heavily items are soiled. Add approximately half the original dose.

Draining the machine

6. To maintain good washing results the machine should be drained and refilled every two hours or at the end of each shift, depending on the frequency of use and how soiled the items being washed are.

7. Leave the machine switched on (1). Open the door and remove the overflow pipe (A), situated off-centre, from the tank.

DO NOT REMOVE THE GREY PLASTIC FILTERS (B), THIS PROTECTS THE DRAIN PUMP FROM PIPS AND OTHER ITEMS. BLOCKED DRAIN PUMPS ARE NOT COVERED BY WARRANTY.

8. Press and hold the drain pump switch (3) for at least 1 second and the machine will automatically empty the wash tank water. This will be indicated by (7), (9) and (11). Once the machine is completely drained, the machine will turn off and the STAND-BY (10) mode will turn on.

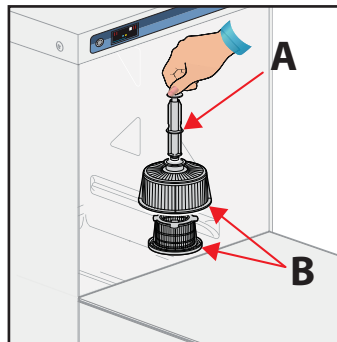

Fig.2

9. Firstly remove any (food) particles from the base of the wash tank and only then remove the pump filters (B) Fig.2 and clean under running water. Make sure that no particles fall into the pump opening, as this could lead to pump damage. Once they are clean refit the filters and a self-cleaning/rinsing cycle can be initiated. While in STAND-BY (10), press the START button (2) for 5 seconds and the cycle will run for 15 seconds and return to STAND-BY. Press the drain switch (3) again. When the pump stops: **DO NOT FORGET TO REFIT THE OVERFLOW PIPE.**

At the end of the day the machine should be drained, switched off and the door left open to ventilate.

Washing

3. Remove any loose food scraps and soil. Place items in the rack correctly making sure the hollow-ware is inverted. Slide the rack into the machine in the direction as shown in Fig.1 and close the door.

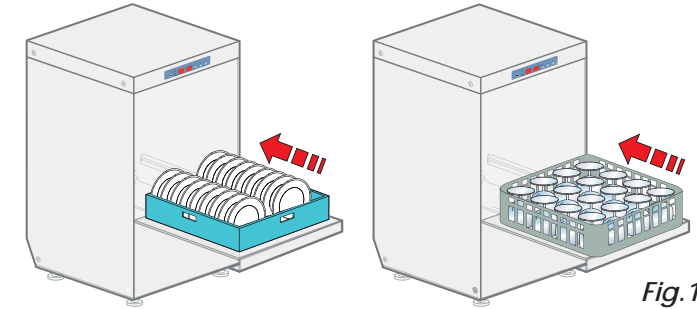

Fig.1

4. Select the required wash cycle by pushing the START button (2) and the cycle indicators (6) will start scrolling. Release the button when the required cycle is lit. Press the start button (2) for approximately 1 second. The cycle will begin with the cycle indicator (6) flashing and the progress of the scroll bar (11).
5. At the end of the washing cycle the hot rinse will happen. The START button (2) will flash when the cycle is completed. Open the door and remove the rack to air dry.

Regular Maintenance

10. Remove the fixing screw (D) to remove the wash arms. Check that the nozzles (E) on the wash arms (C) are not blocked. The nozzles and wash arms can be removed for cleaning. See Fig.3

11. Remove any food scraps from the drain opening. Clean the cabinet inside and out. **DO NOT CLEAN MACHINE WITH HIGH FOAMING LIQUIDS.** Never use aggressive or abrasive products.

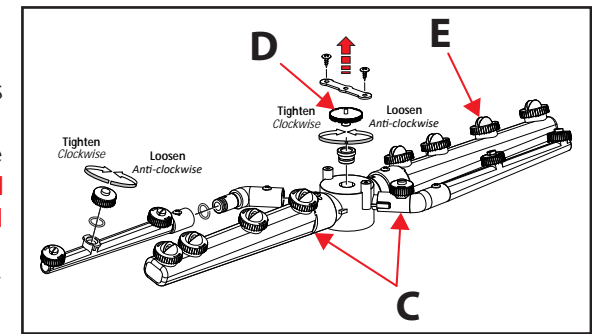

Fig.3

12. Reassemble the parts by attaching the wash arms firmly in place on the assembly (the wash arms (C) must be installed with the correct axial angle). Take care when attaching the nozzles (E) onto their correct positions on the wash arms. Reinstall the wash arm assembly using the fixing screw (D).

THIS MACHINE IS NOT A DUSTBIN. GOOD MAINTENANCE PREVENTS UNNECESSARY BREAKDOWNS. THE CLEANER THE MACHINE IS KEPT, THE BETTER THE FINAL RESULT.

TYPE OF ALARM	CAUSE	INSTRUCTION
door	THE DOOR IS OPEN	Close the door
B2	BOILER PROBE FAILED	Contact Technical Service
B3	BOILER HEATING ALARM	Contact Technical Service
B5	BOILER OVER HEATING	Contact Technical Service
E1	WATER LOAD FAILED	Open the water supply valve & check the overflow pipe
E2	TANK PROBE FAILED	Contact Technical Service
E5	TANK OVERHEATING	Contact Technical Service
E6	TANK DRAINING FAILED	Check the overflow pipe. Contact Technical Service
10	BREAK TANK FILLING	Contact Technical Service